

Lillian

HEATED TOWEL RAIL, 600 x 1208 MM

Features

- Designed for use in bathrooms
- Modern vintage design
- Heat transfer dries towels faster and more evenly keeping them fresh
- 9 bar ladder rails
- Concealed (hard-wired) wiring installation
- Wiring position at top right or bottom left mounting points
- Surface temperature between 45°C and 50°C
- Made from 304 stainless steel

230V | 115W | IP55 RATING
SAA Approved



*Modern
Vintage*
COLLECTION

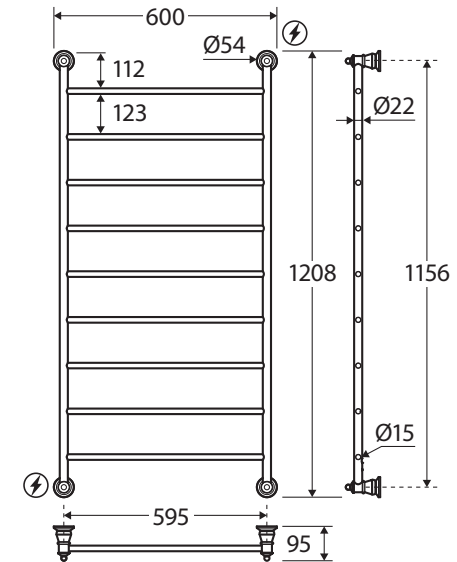
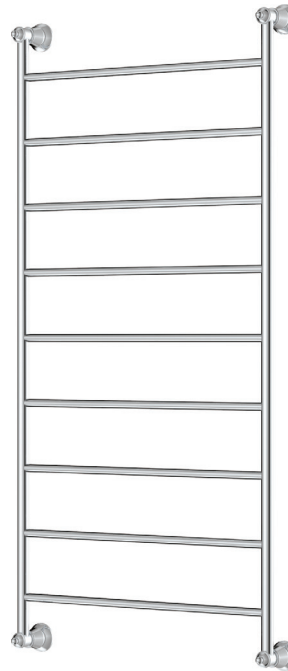

⚡ Wiring Positions

Available in



Chrome
81060120



PVD Brushed Nickel
81060120BN



Powder Coated
Matte Black
81060120MB



PVD Urban Brass
81060120UB

Cleaning & Care

- Regularly clean with mild soapy water using a microfibre cloth.
- In highly polluted or coastal locations, we recommend cleaning 2-3 times per week.
- Do not use harsh detergents, bleach, cream cleaners or citrus based cleaners. These substances are abrasive and will damage the surface.
- Do not use undue pressure and wipe in one direction only

While we aim to ensure specifications are correct at the time of publication, Fienza reserves the right to make modifications without prior notice. Physical colour may vary from image shown. All measurements are shown in millimetres. Always use physical product measurements for mark-ups and roughing-in as the technical drawing may differ from actual product received.