

Mirror Cabinet

600MM WITH 2 SIDE SHELVES

Features

- 5 mm thick mirrors, available with bevel or pencil edge
- Mirror treated with resin emulsion paint to protect against corrosion
- Soft-close doors
- Three internal board shelves
- Made from E1 MDF board with a 2-Pac gloss white finish
- Strong 16 mm thick backing board

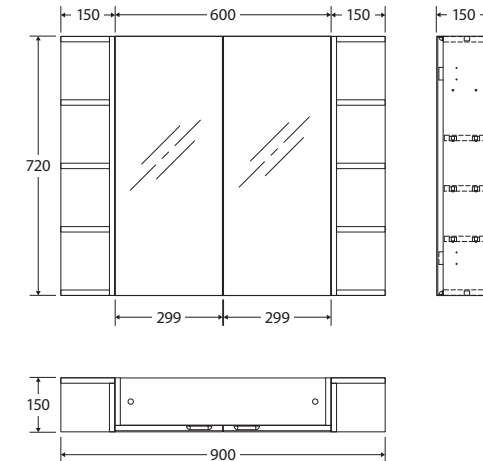
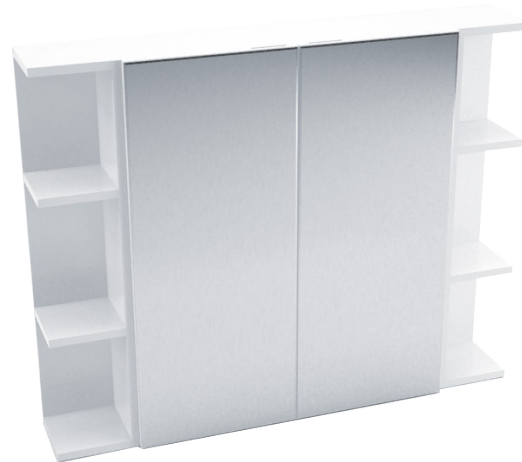

Available in



Gloss White with
Bevel Edge Mirrors
BSS90



Gloss White with
Pencil Edge Mirrors
PSS90

Easy to install: with high quality backing boards, fixings can be placed anywhere through the back of the cabinet.

Cleaning & Care

- Clean mirrors with a combination of 30% methylated spirits to 70% water and a soft cloth designed for use on glass surfaces.
- Clean cabinet with mild soapy water using a clean, soft cloth.
- Do not use harsh detergents, bleach, abrasive cleaners or cream/wax cleaners. These substances can result in scratches and/or deposit build-ups that will affect the appearance.
- Avoid placing hot objects, such as hair straighteners, on any surface as these will cause discolouration and marking.
- Spills of hair dye, after-shave lotion, nail polish and remover, aerosol spray and other harsh chemicals should be removed immediately to prevent damage and discolouration.

While we aim to ensure specifications are correct at the time of publication, Fienza reserves the right to make modifications without prior notice. Physical colour may vary from image shown. All measurements are shown in millimetres. For MDF cabinetry, please allow +/- 5 mm tolerance per 1000 mm for manufacturing variance in straightness. Always use physical product measurements for mark-ups and roughing-in as the technical drawing may differ from actual product received.