

# ACES Installation Instructions

## Alpine Corner Entry Square

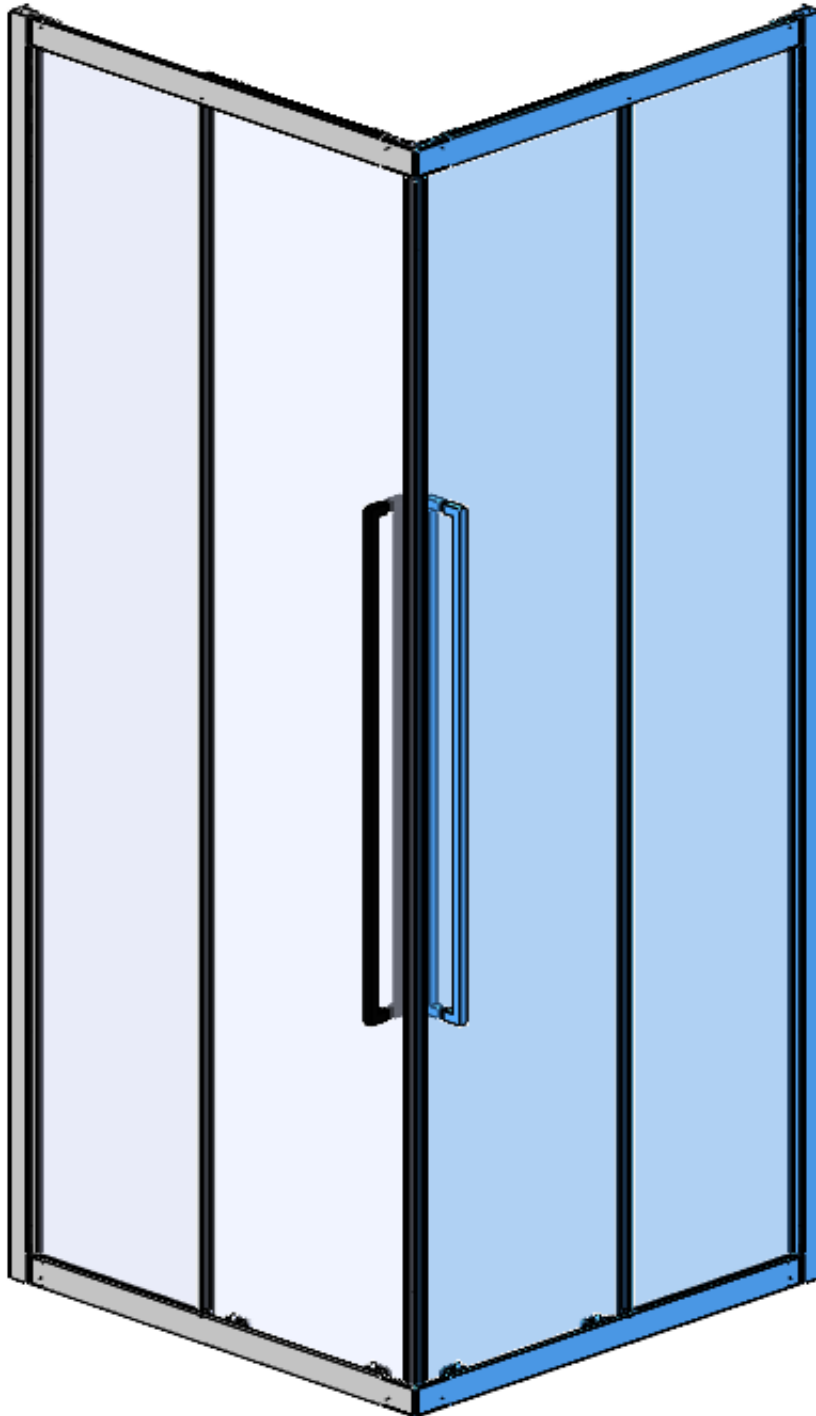

[alpinekb.au](http://alpinekb.au)



WEST AUSTRALIAN  
OWNED & OPERATED  
MANUFACTURING

Please read these instructions carefully and retain them for future reference.

**\*\*1. For ease and safety, we recommend that two people assemble this product. \*\***

**\*\*2. Protect shower tray surfaces at all times. \*\***

**\*\*3. Exposed glass corners or edges must not contact hard surfaces at any time. \*\***

**\*\*4. Check for cables, pipes, etc. before drilling walls. \*\***

**\*\*5. Ensure that all surfaces are dry, clean, and free of loose debris or dust. \*\***

**\*\*6. Unpack the goods with care. (Small parts can become lodged in the packaging and inadvertently discarded.) Check the parts supplied against the parts and fittings listed herein. Damaged parts or omissions may be resolved by calling the Alpine Bathrooms Helpline. \*\***

**\*\*7. While precautions are taken in manufacture, care must be taken when handling as rail ends may have sharp edges. \*\***

**\*\*8. Before commencing, check: \*\***

\* a) that the shower tray is level and completely sealed to the finished/tiled walls.

\* b) that the finished walls are sound and free of cracks, loose tiles, or grout.

**\*\*9. AFTER INSTALLATION, DO NOT "WET" ENCLOSURE FOR 48 HOURS TO ENSURE FULL CURE OF THE SILICONE SEALANT). \*\***

**\*\*General Care and Maintenance\*\***

Provided this product is installed and operated in accordance with these instructions, problems should not arise. However, should maintenance be required, it should be carried out by a competent person with reference to these instructions. Before any work is carried out, the root cause of the problem must be identified. Alpine service engineers are available if necessary to consult or carry out remedial work.

**\*\*Cleaning\*\***

(Every one to two weeks depending on local water {hardness} conditions)

All glass panels in this product have a hydrophobic coating aiding "runoff" of water droplets, reducing the need for frequent cleaning.

For best appearance and product life, however, regular cleaning is recommended.

Use ONLY mild soap or detergent solutions to clean. Rinse with water, squeegee glass panels, and wipe frames dry with a soft cloth. Under no circumstances should abrasive, caustic, or scouring products be used. Non-compliance with these cleaning instructions may cause decorative finishes to deteriorate and could adversely affect safe operation of the enclosure.

**\*\*Limescale\*\***

- Should a build up of limescale occur, remove using a 50:50 solution of white vinegar and water applied with a soft cloth and rinsed/dried thoroughly afterwards.

**\*\*Daily Care\*\***

To prevent the build up of limescale, do not allow water droplets to dry on glass or frames. After showering, rinse with water, remove droplets from glass with a squeegee, and wipe frame with a soft cloth.

**\*\*What to do if something goes wrong: \*\***

Should the product not function correctly on initial use, firstly, contact the installer to check that unit installation and commissioning are in accordance with these instructions. Should this not resolve difficulties or should performance decline, consult the "Troubleshooting" section to see if simple home maintenance is needed.

Alternatively, Alpine staff can assist, or if necessary arrange for a service engineer to visit.

**\*\*Spares: \*\***

We maintain extensive spare part stocks. Spares can be ordered or purchased from your local Alpine stockist.

**Parts Supplied in this box:**

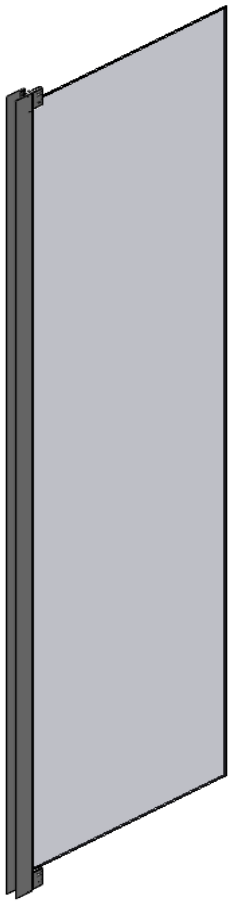

**Fixed Panel**



**Sliding Door**

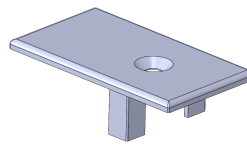

**1 x Top cap**

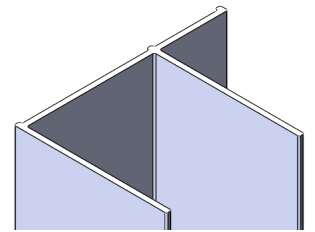

**1 x Wall Profiles**

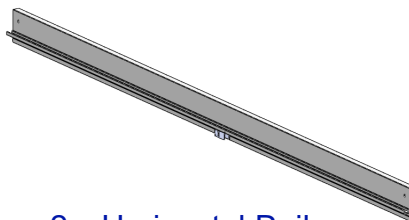

**2 x Horizontal Rails**

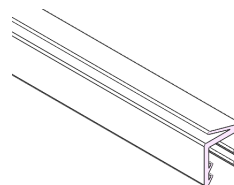

**2 x Horizontal glazing seal**

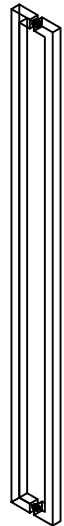

**1 x Door Handle**

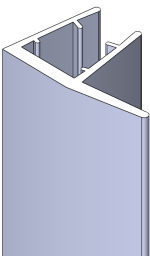

**Edge seal**  
1x 1973mm (door)  
1x 1910mm (fixed panel)

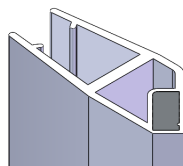

**Magnetic seal**  
1x 1973mm

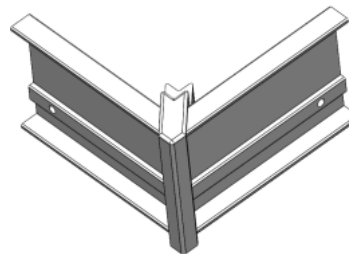

**1 x Corner Block**

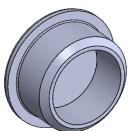

**2 x Cover Cap**

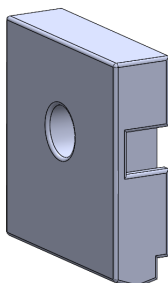

**2 x Doorstop Block**

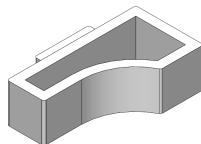

**2 x Doorstop**



**8 x Screw Cup Washers**



**8 x Screw Cover Caps**



**5 x 3.5x12mm long Csk Head Self Tapping Screws**



**4 x 3.5x12mm long Pan Head Self Tapping Screws**



**4 x 4x45mm long Pan Head Self Tapping Screws**

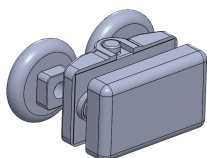

**2 x Top wheels**

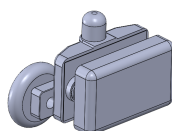

**2 x Bottom wheels**



**4 x Wall Plugs**

SIZE	Adjustment Range A
090	850—880mm
100	950—980mm
120	1150—1180mm

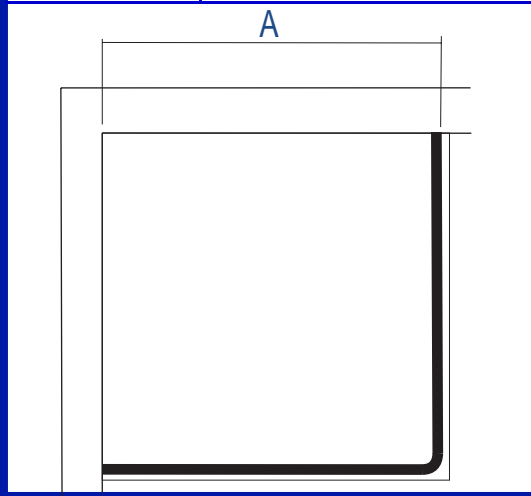

### Tools Required

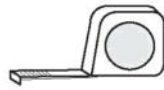

Tape Measure



Pencil



3mm HSS drill bit

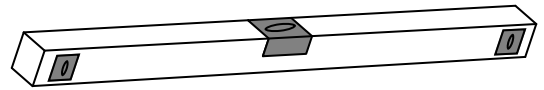

Spirit Level (with vertical 'bubble')



Phillips Screwdriver



Power drill with 8mm masonry drill bit

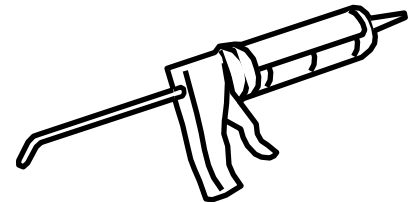

Good quality silicone sealant & applicator

### Step 1: Fix the first wall profile to the wall

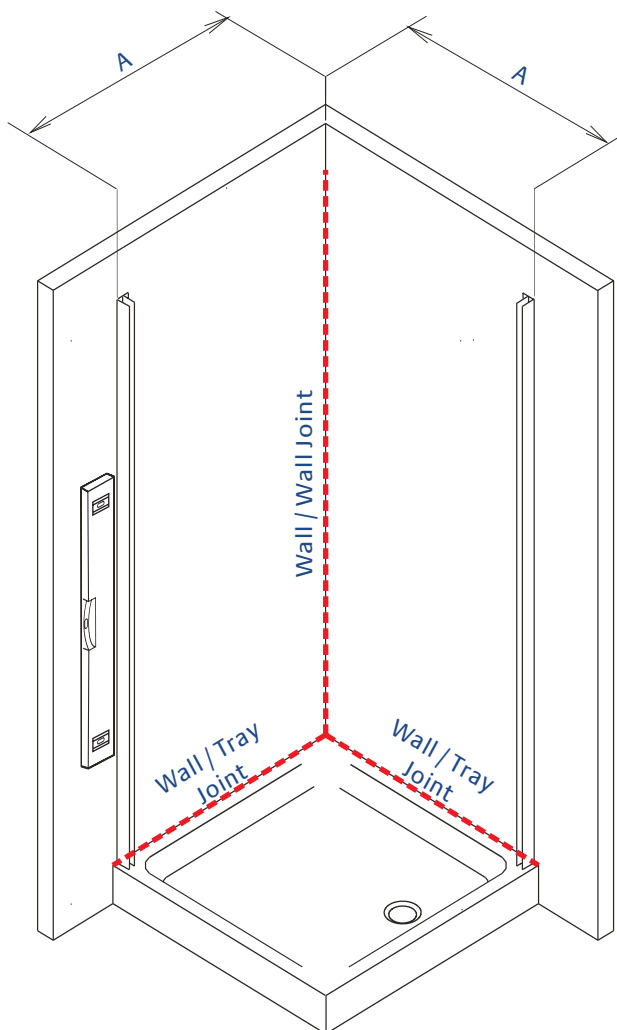

Ensure you have a continuous silicone sealant bead around your shower base before fitting the profiles

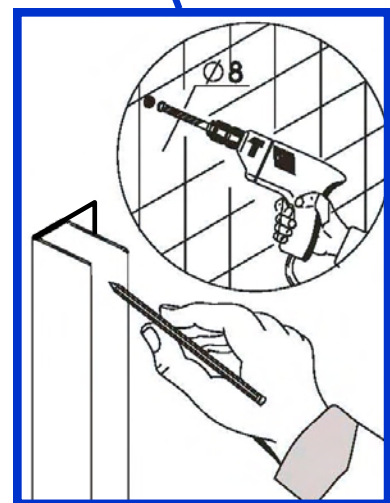
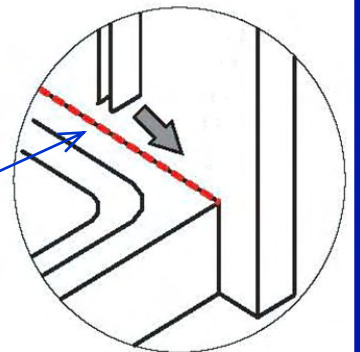

Wall profile orientation : Mounting holes go to the inside of the shower (wet area).  
 Measure, plumb & mark wall profile positions, drill, plug & affix 1 wall profile only at this time

**Step 2: Assemble the frame**

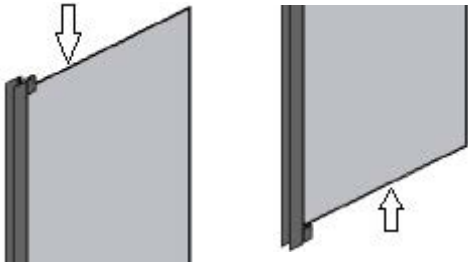

Horizontal glazing seal

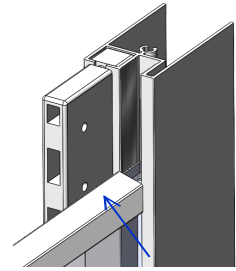

1: Install the horizontal glazing seal to the top and the bottom glass of the fixed panel

The seal end should touch the aluminum

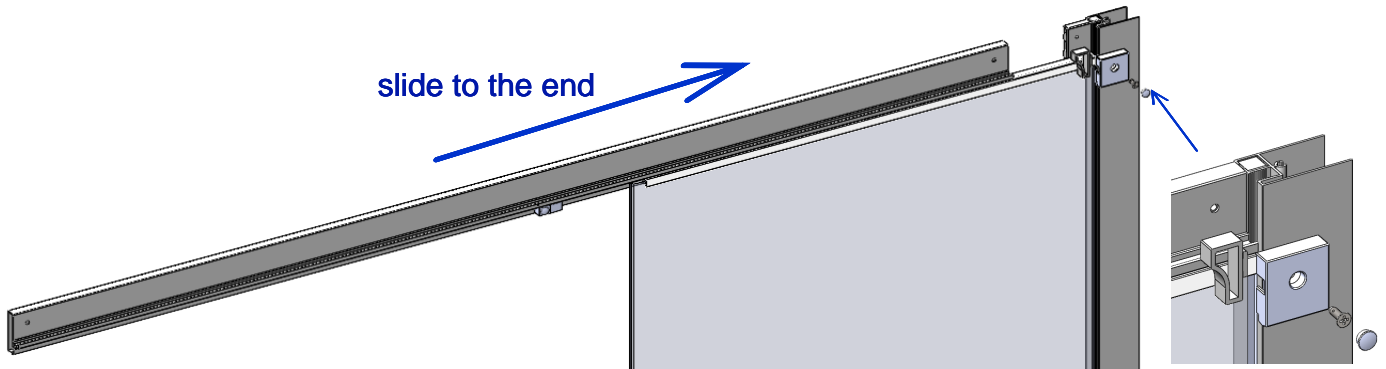

2: Install the horizontal rails to the top and bottom of the fixed panel, align & fit the door stops with 3.5x12mm Csk screw & fit the cover caps.

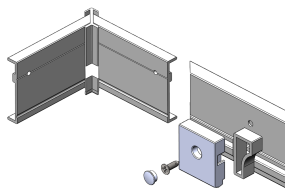

Push In

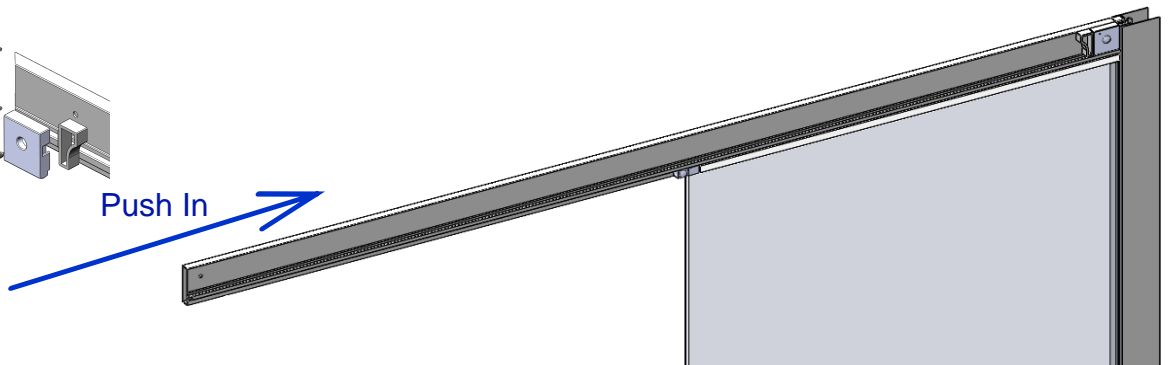

3: Install the corner block, align & fit door stop with 3.5x12 Csk screw & fit cover caps.

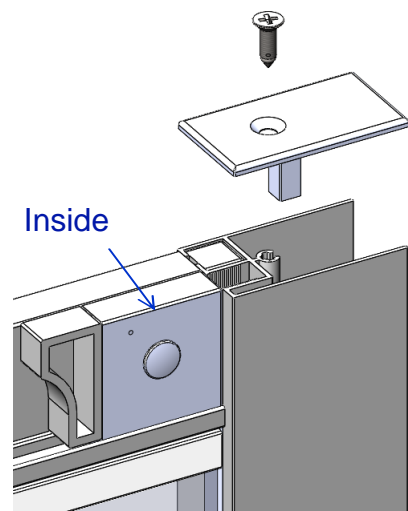
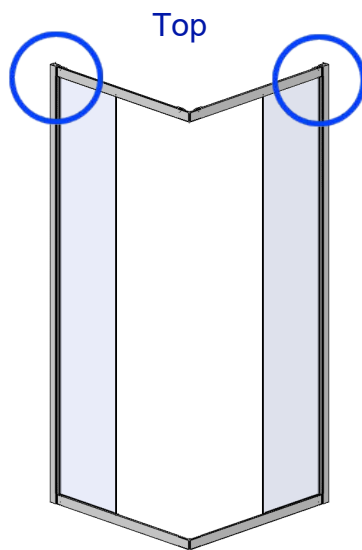

4: Install the top cap to the fixed panel.

Lets get this door level and fix it to the wall profiles

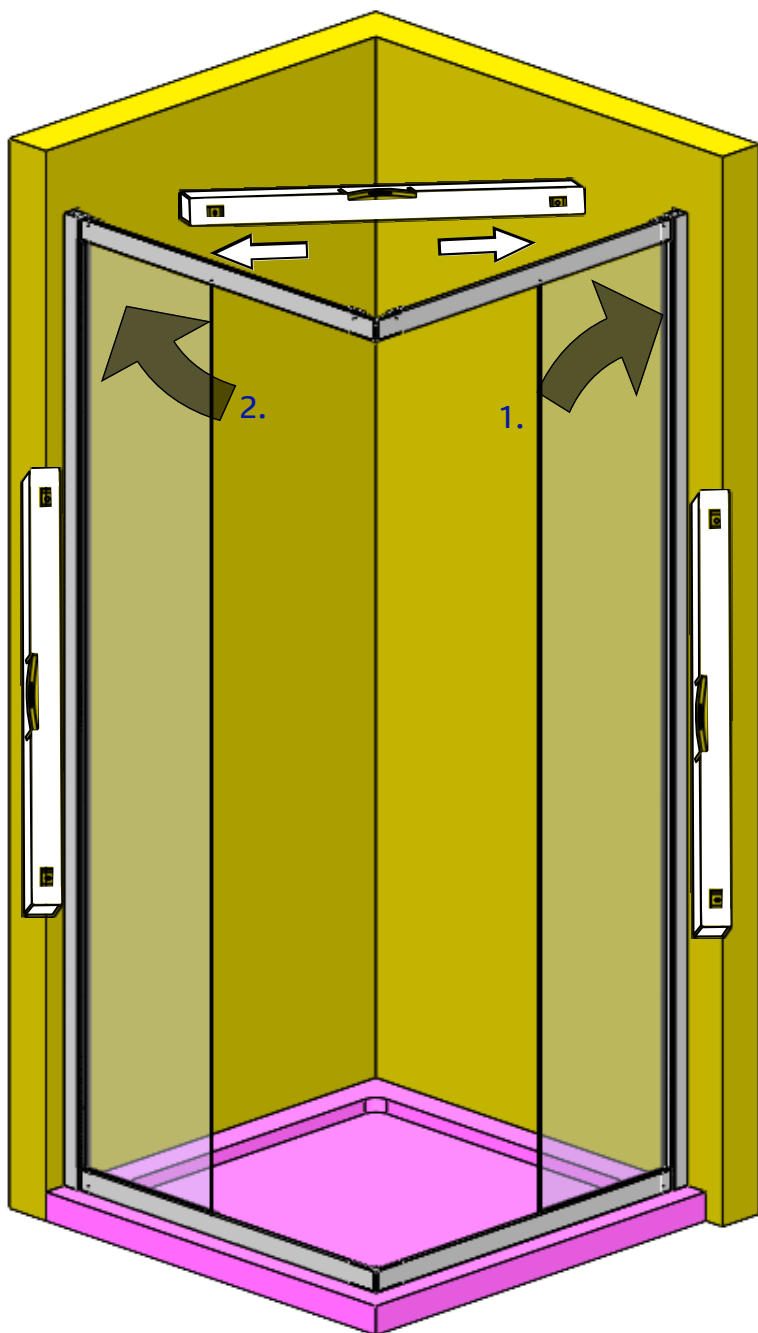

Once the door is in place you can attached the handle to the door

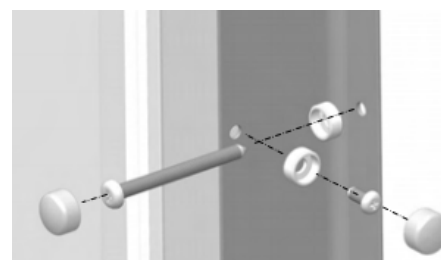
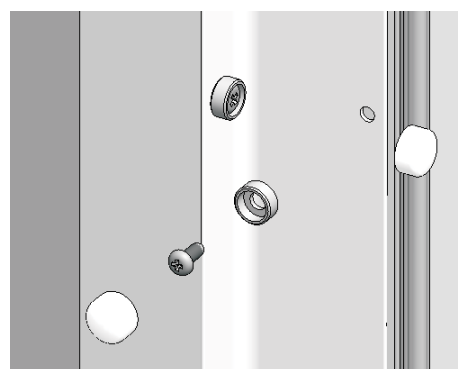
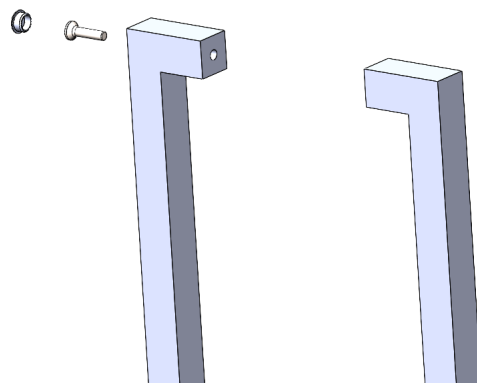

1. Carefully lift door into place and push it into fixed wall profile.
2. Using the adjustment in the wall profiles carefully slide, push back and align the door into place.
3. Affix the second wall profile to the wall using 4 x 45 mm long screws and cup washers.
4. From the inside of the shower door using the wall profile holes as a guide drill (dia 3mm) holes into the door frame one at a time, then screw in the supplied 12mm screws and screw cup washers after drilling each hole. Repeat this process 8 times (4 per wall profile)
5. Push on the screw cover caps onto all the cup washers, including all the wall profile screws.

# Install the doors

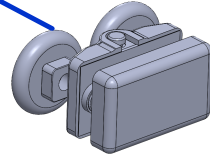
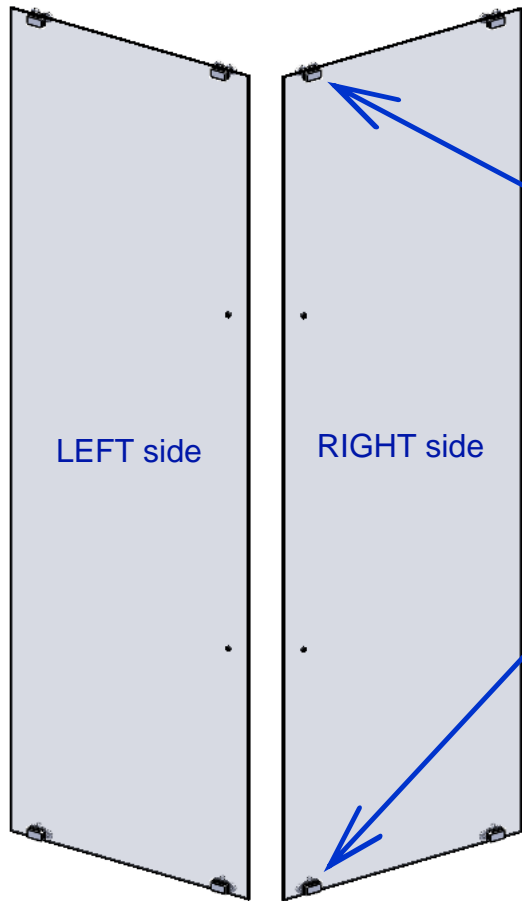

2 x Top wheels

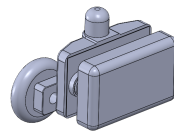

2 x Bottom wheels

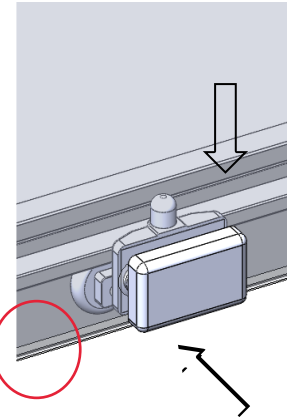
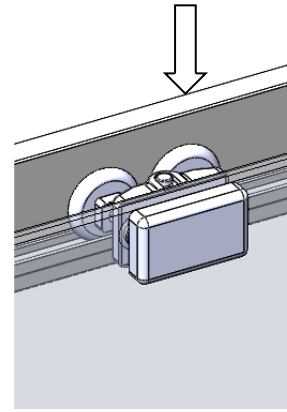

Using the buttons engage the bottom wheels into the bottom rail.

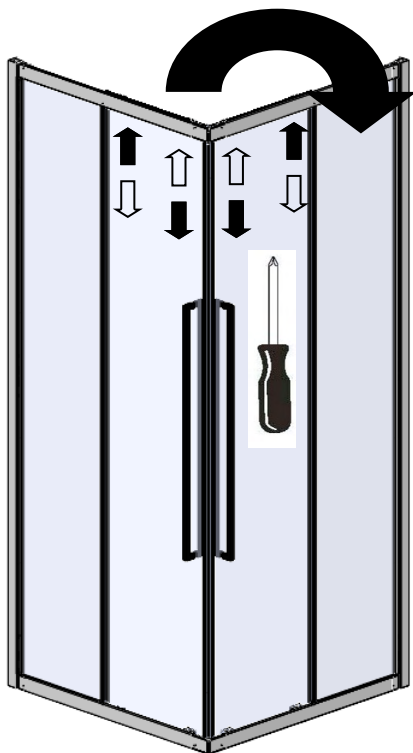

By turning the screws on the top wheels adjust door heights until even & the doors run smoothly. Adjust door angles so that magnetic seals hold door closed with no gaps.

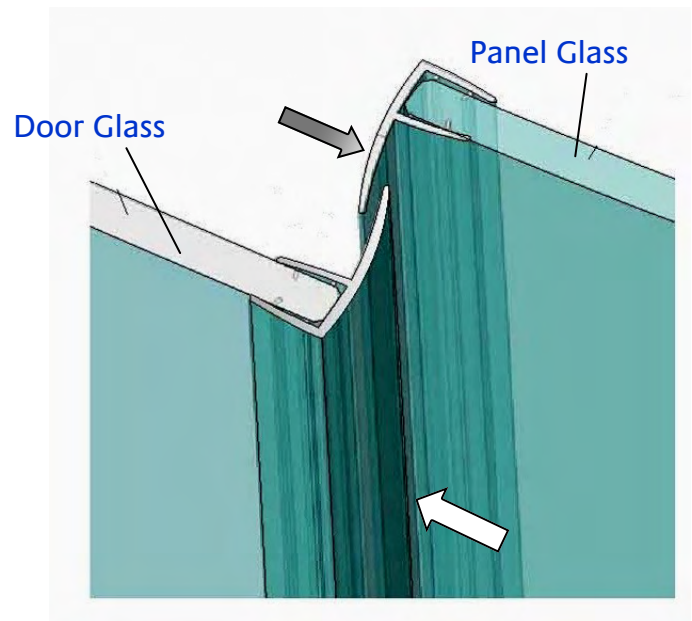

Fit edge seals to trailing edge of door & leading edge of fixed panel.

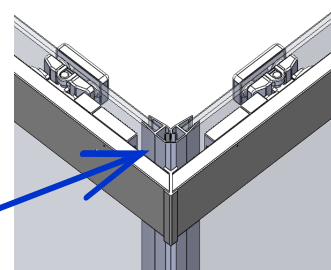

Fit magnetic seal to leading edge of doors.

Almost there, it's time to seal the shower door

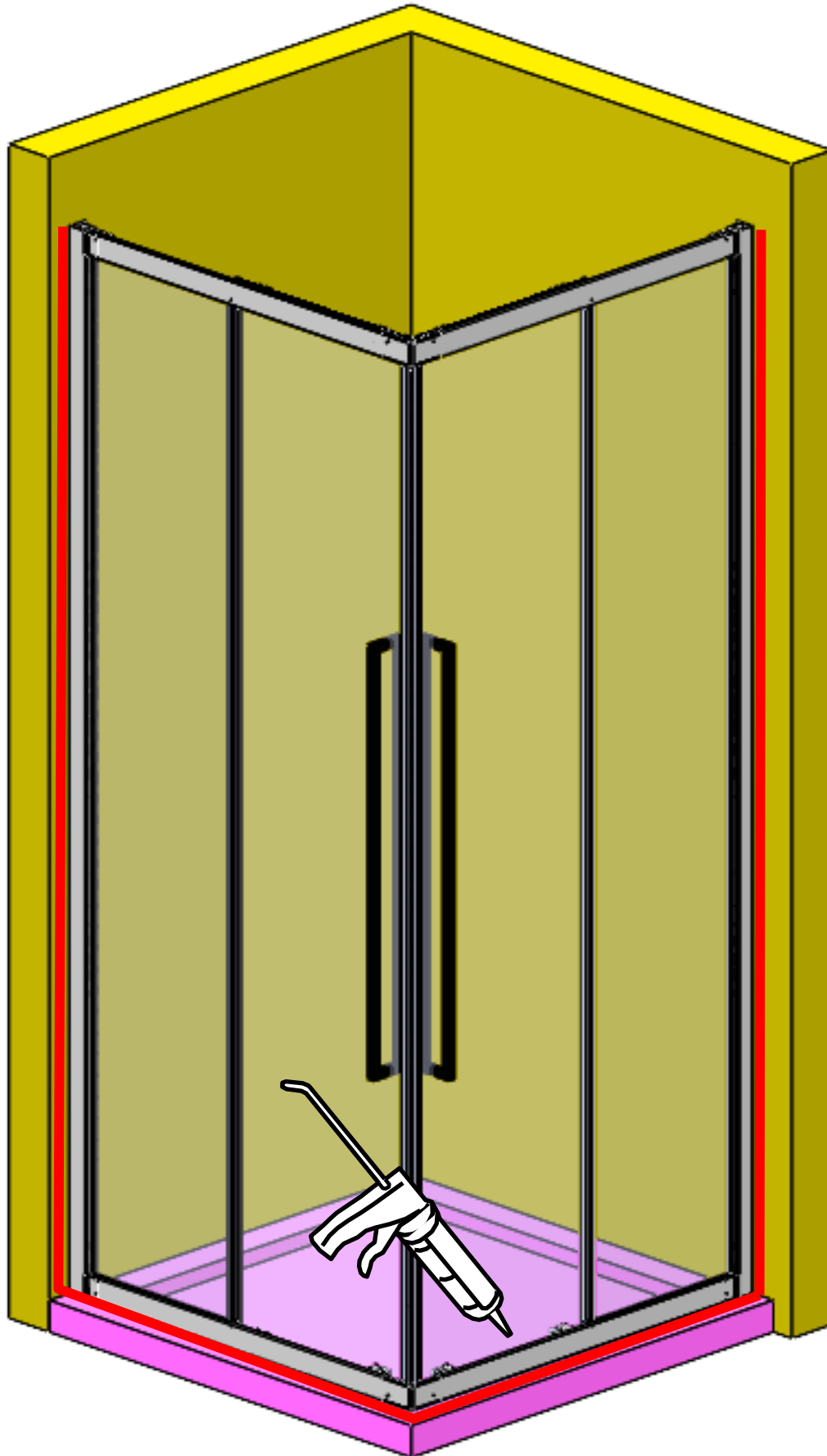

Use of good quality silicone sealant.  
Cleaning / degreasing of all joint areas is recommended.  
Apply continuous silicone sealant bead EXTERNALLY ONLY