



VUAS75

Astra

75cm

FEATURES & BENEFITS

- Durable white high gloss finish to all sides
- Designed for easy installation
- Fully assembled (no assembly required)
- Soft closing drawers and doors
- Finger pull Doors and Draws

SIZE

- 750mm W x 465mm D x 840mm H

COLOUR

- Gloss White

MANUFACTURING MATERIALS

- High Grade HMR (Highly Moisture Resistant) Board
- Ceramic China Top

GUARANTEE

- All Alpine cabinets come with a genuine 5 Year Warranty which covers materials used and workmanship at the time of manufacture.

Dimensions and set-outs are correct at the time of publication, however the manufacturer/ distributor takes no responsibility for printing errors.

The manufacturer/distributor reserves the right to vary specifications or delete models from their range without prior notification.

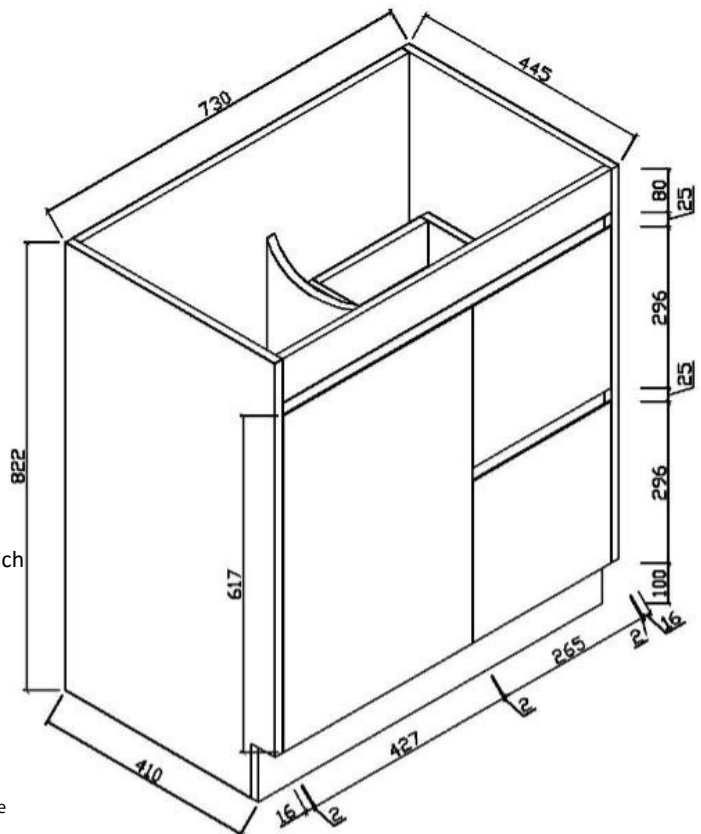

www.alpinekb.com.au